

# **SafeAir M300 Pro**

# **SafeAir M350 Pro**

---

**(ASTM F3322-18 Compliant)**

USER MANUAL

# Table of Contents

<b>GENERAL INFORMATION .....</b>	<b>4</b>
1.1 Introduction .....	4
1.2 Technical Specifications .....	5
1.3 Maintenance .....	5
<b>SAFETY INSTRUCTIONS.....</b>	<b>6</b>
<b>PACKAGE CONTENTS .....</b>	<b>7</b>
<b>SMARTAIR CONNECTORS OVERVIEW.....</b>	<b>8</b>
<b>INSTALLATION .....</b>	<b>9</b>
5.1 Connecting the Mounting Legs to the Drone .....	9
5.2 Connecting the Electronic TerminateAir .....	10
5.3 Flight Preparations .....	12
5.4 Inserting the Pyro Actuator .....	12
5.5 Inserting the Parachute .....	14
<b>REMOTE CONTROLLER (OPTIONAL).....</b>	<b>16</b>
6.1 RC 1.0 System Ports & Switches.....	16
6.2 RC 1.0 System Status and Troubleshooting .....	17
6.3 RC 1.0 System Specifications .....	17
6.4 RC 2.0 System Ports & Switches.....	18
6.5 RC 2.0 Main Screen Messages .....	19
6.6 RC 2.0 Idle Screen .....	21
6.7 RC 2.0 Charging Indications.....	21
6.8 RC 2.0 System Specifications .....	21
<b>SYSTEM LED INDICATIONS .....</b>	<b>22</b>
<b>OPERATING GUIDELINES .....</b>	<b>24</b>
8.1 Preflight.....	24
8.2 Takeoff .....	24
8.3 Before Landing.....	24
8.4 After Landing .....	25
8.5 FTS Test (for RC equipped systems).....	25
<b>DEPLOYMENT.....</b>	<b>27</b>
9.1 General .....	27
9.2 Repacking the parachute .....	27

## Important Notice

ParaZero's SafeAir M300 Pro / SafeAir M350 Pro (ASTM F3322-18 compliant) is a drone safety system that mitigates operational risk and aims to lower potential ground impact kinetic energy during proper use. ParaZero's drone safety system is not intended to eliminate all damages to people or property and ParaZero cannot guarantee this. ParaZero's drone safety system is a ballistic parachute system that uses a pyrotechnic component to instigate parachute deployment. Please note, you must read, comply with, and apply all written information in this manual. The responsibility for proper use of the drone safety system is placed solely on the user.

Copyright © 2024 ParaZero Drone Safety Systems. All rights reserved.

All intellectual property rights in this publication are owned by ParaZero Drone Safety Systems and protected by applicable copyright laws and international treaty provisions. ParaZero Drone Safety Systems retains all rights not expressly granted. No part of this publication may be reproduced in any form whatsoever or used to make any derivative work without prior written approval by ParaZero Drone Safety Systems. All other trademarks are the property of their respective owners. Other company and brand products and service names are trademarks or registered trademarks of their respective holders.

## Document Information

SafeAir M300 Pro / SafeAir M350 Pro User Manual

Number of pages: 30

Last update: February 7, 2024

Version: 1.32

## Contact Information

**Telephone:** +972-36885252

**Address:** 30 Dov Hoz St

Kiryat Ono, Israel 5555626

<https://parazero.com/>

## About This Guide

This user guide describes the installation and proper use of the ParaZero SafeAir M300 Pro / SafeAir M350 Pro (ASTM F3322- 18 compliant) drone safety system, compatible with the following Matrice versions:

- Matrice 300 RTK
- Matrice 350 RTK



# General information

## 1.1 Introduction

**Caution** During all installation stages, be sure –



- Not to connect the batteries to the drone
- Not to connect the TerminateAir to the SmartAir

The ParaZero SafeAir M300 Pro / SafeAir M350 Pro is smart-parachute system that deploys autonomously after detecting a critical failure in your drone. When deployed, the parachute slows the descent rate of your drone and reduces the potential ground impact kinetic energy. The system incorporates the following main components:

- 1** A unique, patented ballistic parachute deployment system for near zero-time deployment, designed for operations at very low altitudes, across a range of flight envelopes, including zero speed (hover).
- 2** A completely autonomous identification and activation capability, using the dedicated SmartAir™ Pro autonomous triggering system (ATS).
- 3** A DJI M300 dedicated, independent flight termination system (FTS), called TerminateAir™. The M300 TerminateAir™ controls the power supply of the drone for emergency shutdown scenarios.

The system is designed for fast assembly and detachment, using only four tool-free screws. The SafeAir™ M300 Pro / SafeAir M350 Pro drone safety system incorporates the following features:

- 1** Deployment in a fraction of a second
- 2** Independent, autonomous detection of critical failures in a DJI M300 RTK / DJI M350 RTK drone, including XYZ acceleration, critical angles, and extreme maneuvers
- 3** Weather detectors
- 4** Effectiveness at low altitudes and zero speed
- 5** Effectiveness at extreme roll angles and at maximum speed
- 6** Audio and visual warnings
- 7** Easy, user-friendly Installation process
- 8** Access to data logs via the desktop application

## 1.2 Technical Specifications

The SafeAir™ M300 Pro / SafeAir M350 Pro system should only be operated in open air and in normal weather conditions.

### Technical Specifications

Criterion	Specification
Expected Reaction Time	Up to 50ms
Minimum safe altitude	30.39m (99.7ft) AGL
Average descent rate at maximum takeoff weight 9kg (19.84lbs)	4.41m/s (14.46ft/s)
Total system weight	900g (1.98lbs)
Temperature Range	-20°C to +60°C (-4°F to +140°F) when the system is fully charged
Maximum Wind Speed	9 m/s (17.5 knots)
Humidity	90% @ 35°C (95°F)
Parachute repack cycle	2 years
Maximum number of deployments	5
Service life	5 years
Maximum Takeoff Weight	9kg (19.84lbs)
Maximum altitude above mean sea level	3,000m (9,842ft)

\*ISA, at zero wind and stabilized vertical speed.

## 1.3 Maintenance

The SafeAir™ M300 Pro / SafeAir™ M350 Pro system should undergo period maintenance procedures once every two years. The first periodic maintenance schedule is set for two years from the manufacturing date and appears printed on the system itself and on its box.

The maintenance should be performed by ParaZero or a designated, certified agent.

For more information, please contact [support@parazero.com](mailto:support@parazero.com).



## Safety Instructions

**Caution** Before you begin the installation process, read these safety instructions carefully!  
 Follow the instructions in this guide in the exact order in which they are presented, in order to ensure your own safety as well as the safety of others.

The ParaZero SafeAir M300 Pro / SafeAir M350 Pro is a safety system designed to deploy almost instantaneously, by using a special pyrotechnic ballistic mechanism, which must be handled with caution.

ParaZero's SafeAir systems are professional safety devices. As such, it is important that we are able to contact you in case there are important updates, safety alerts or recalls. In order to support ParaZero's ability to quickly reach you in case of a safety alert, please register your system with your contact information at: <https://parazero.com/product-registration/>



**SafeAir M300 Pro / SafeAir M350 Pro System**

The system incorporates a safety pin, which acts as an on-off button and electrically prevents the activation of the system

**Do not remove the safety pin until specifically instructed to do so in this guide.**

This manual explains how the SafeAir M300 Pro / SafeAir M350 Pro works and how to properly operate the system on the ground and in the air. Be sure to take the time to read this manual carefully in order to increase your safety and the safety of those around you.

**Note** – Using the SafeAir M300 Pro / SafeAir M350 Pro System does not eliminate all risks associated with drone operations. Please fly responsibly and in accordance with the rules and regulations defined by authorities in the area(s) where you are operating.

Visit the ParaZero website (<https://parazero.com/>) on a regular basis for the latest information and updates. It is imperative to perform system updates on a regular basis through the desktop application.

The current version number is found on the product webpage: [www.parazero.com/m300Pro](http://www.parazero.com/m300Pro) under the software tab. A new device must be updated prior to first flight.



## Package Contents

The SafeAir M300 Pro / SafeAir M350 Pro package includes the following parts:

**Table 1 – SafeAir M300 Pro / SafeAir M350 Pro Package Contents**

#	Description
<b>1</b>	The main bracket, including the canister plus rubber band, the SmartAir Pro (SAP) with a safety pin and pyro dummy
<b>2</b>	The electronic TerminateAir M300 Pro / TerminateAir M350 Pro (2 identical parts)
<b>3</b>	Mounting bracket plus 4 thumb screws for fast connection of the system
<b>Parachute box</b>	
<b>4</b>	The parachute, folded between a red base and a yellow cap
<b>5</b>	4 strings
<b>Tools and cables box</b>	
<b>6</b>	USB-C cable (for the SAP)
<b>7</b>	TerminateAir cables for electronic TerminateAir M-300 / M-350 – 1x long black cable, 1x short black cable
<b>8</b>	TerminateAir locker
<b>9</b>	4 screws to connect the main bracket to the mounting bracket, 4 washers, 4 spring washers, large and small Allen keys
<b>10</b>	External antenna – Optional
<b>The Remote Controller box</b>	
<b>11</b>	Remote Controller (RC) – Optional
<b>12</b>	Micro USB cable (*)
<b>Actuator box</b>	
<b>13</b>	A pyro actuator within a metal compartment

(\*) As version 2.0 of the Remote Controller, a USB-C cable is required and the micro-USB cable is not provided



## SmartAir Connectors Overview

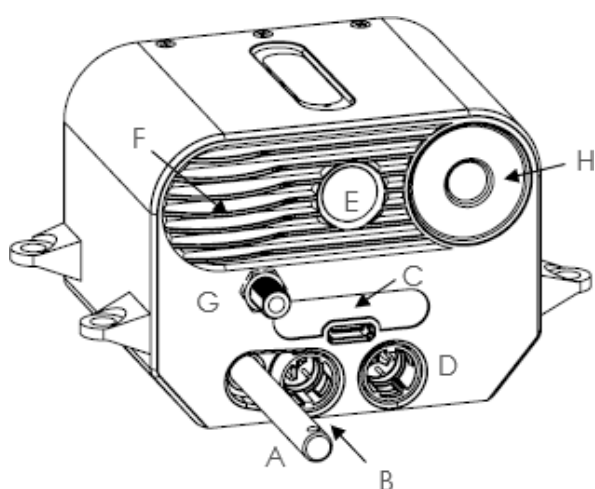

- A – 2 Stage Safety pin  
Stage 1 – Power on/off  
Stage 2 – Pyro safety
- B – FTS/UART connector  
(optional Vin & PWM)
- C – USB-C connector
- D – Parachute cable connector
- E – RGB LED
- F – Inner buzzer
- G – External antenna connector (some models)
- H – System button (advanced users)





## Installation ([installation video link](#))

### 5.1 Connecting the parachute system to the drone

- 1 Connect the mounting bracket to the forward upper part of the drone, by screwing the four thumb screws



- 2 Position the parachute system on the mounting bracket, the SAP should face the rear of the drone



- 3 Attach the four screws, four spring washers, and four washers (in this order). Tightly secure the screws using the small Allen key. The parachute cable should be inserted through the carbon plate as indicated in the photo



- 4 Optional – connect the external antenna to the SAP and secure it to the drone's leg, in such a way that it won't interfere with the drone or its sensors

## 5.2 Connecting the electronic TerminateAir

- 1** The first stage is to replace the original battery locker with the TerminateAir locker. Position the battery locker in the locked position while the batteries are not installed. Use adhesive tape to prevent the remaining parts from ejecting (or 'popping out') during the process



- 2** Use the provided large Allen key to unscrew and remove the battery locker. Keep the battery locker and its parts in a safe location



- 3** Screw the TerminateAir locker, do not use any washers until secured, and remove the adhesive tape



- 4** Turn the TerminateAir locker into its unlocked position and slide the two TerminateAir parts completely into the battery compartment, until the connector is attached



- 5** Use the long black cable to connect between the two lower ports of the two electronic TerminateAir units. Notice that the white line on the connector and on the port should match

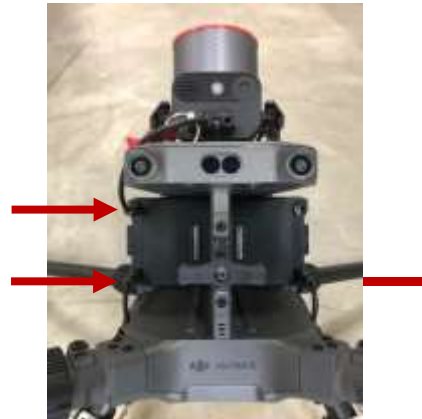

- 6** Use the short black cable to connect between the upper port of the left electronic TerminateAir unit and the FTS port of the SAP. Notice that the white line on the connector and on the port should match



- 7** Install the drone's batteries and lock the TerminateAir locker. Use the TerminateAir locker exactly as the previous battery locker to remove or reinstall the batteries. Verify that the connection is completely secure and there is no freedom of movement between the TerminateAir locker and the batteries



- 8** For storage purposes, bend the TerminateAir locker downwards while in the locked position, be aware that it could only be bent to one position, rotate it by 180 degrees if necessary

## 5.3 Flight Preparations

- 1 The SAP should be charged using the provided USB-C cable for at least three hours prior to the first flight, using a USB power supply. Because the SAP interfaces with the drone's power supply via FTS connectivity, the system is automatically charged during flight, resulting in limitless SafeAir battery operation. If the system is not used often, it should be charged before flight for three hours.

Charge the SAP when the safety pin is all the way in.

- 2 (Optional) Charge the RC using the provided USB cable, using a USB power supply, for at least one hour before first use. Charging should be made while the RC is turned off.

**Caution**



When the RC is turned off or there is no link between the RC and the receiver, manual triggering is not available

- 3 Using the desktop application allows for firmware updates, automatic download of flight logs, and system configuration. Disconnect the FTS cable and the parachute cable from the SAP, remove the safety pin completely, and connect the SAP to your computer using the provided USB-C cable. The desktop application installation and operational instructions may be found [here](#). Use the pyro-dummy connected instead of the parachute cable for the SAP during initialization process.

**Warning**



Please disconnect FTS and parachute cables from the SmartAir to prevent inadvertent activation during the firmware update process

- 4 Perform the self-test assessment found [here](#)

## 5.4 Inserting the Pyro actuator

**Caution** During all installation stages, be sure –



- That the safety pin remains in its proper place
- Not to connect the parachute cable to the SmartAir

- 1 Unscrew the safety transportation capsule and take out the pyro-actuator. When removing the pyro-actuator from the transport capsule, you are obliged to use protective glasses as a safety precaution.
- 2 Insert the pyro-actuator into the socket in the bottom of the container, ensuring that you insert completely to the end of the connection point.

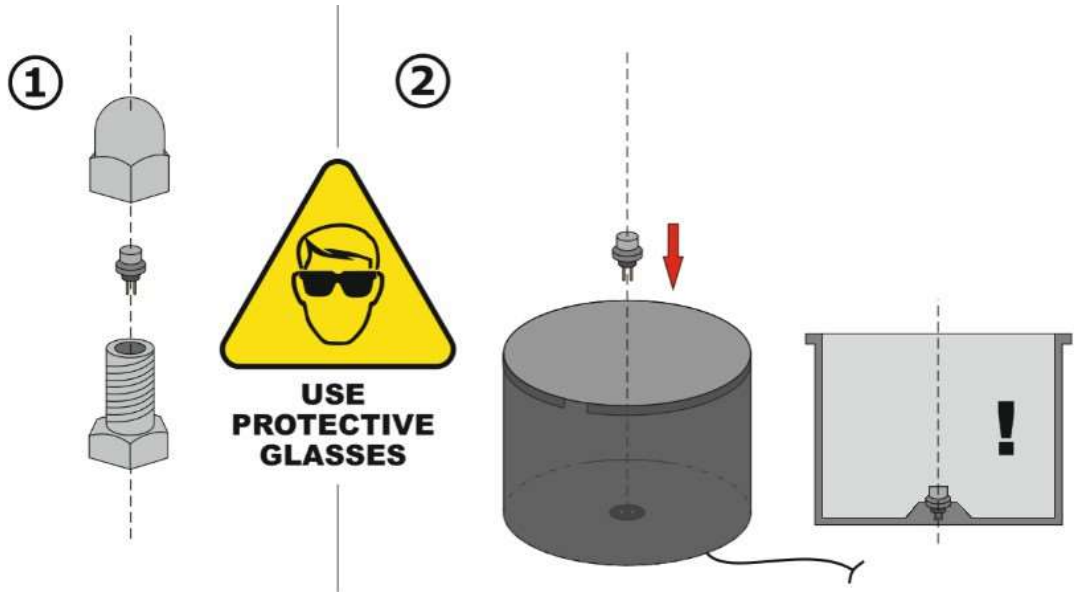

## 5.5 Inserting the parachute

- 1 Hold the folded parachute, remove the rubber bands while applying pressure to the upper yellow cap and the bottom red base. Insert the folded parachute into the Canister so the red base inserts first. Push the parachute in all the way. Remove the yellow cap and squeeze the parachute itself into the canister while removing the paper container out (keep the paper container in a safe place for repack purposes)

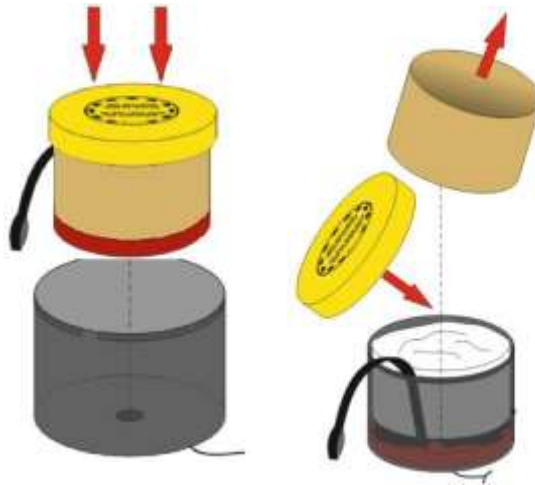

- 2 Do not remove your hand from the top of the parachute. With your other hand, leave the parachute main strap, with the carabiner attached to it outside of the canister, facing the SAP. Place the yellow cap, make sure the cap is secured and that the parachute is not protruding out of the canister or cap
- 3 Secure the carabiner into place by using the provided rubber band



- 4 Connect the four parachute strings to the base of each of the four DJI M300 / 350 RTK arms by wrapping the string around each arm and inserting one end into the string's loop and tightening it as shown in photo



- 5 Insert each loop to the carabiner of the parachute and secure the carabiner



- 6 Secure each parachute string to its designated conduit on the electronic TerminateAir. The strings should not obstruct the DJI M300 / M350 RTK sensors nor the propellers. The strings should climb in a straight line from the conduit and upwards, as indicated in image circled in red





## Remote Controller (optional)







Follow the correct model of your RC.

### 6.1 RC 1.0 System Ports & Switches





## 6.2 RC 1.0 System Status and Troubleshooting

#	LED & buzzer	System status	Corrective action/ explanation
1	Green 	System ready	
2	Blue 	System charges	
3	Sequence of solid blue accompanied by flashing blue 	Charge complete	
4	3x Red flashes + beeps 	No link	SafeAir might be turned off, or the RC is too far from the receiver
5	Yellow + beep every 20 seconds 	RC battery low	The RC will have enough power for 15 minutes. It is advisable to end mission and charge the RC
6	Magenta flashes 	Trigger switch problem	Try to manually release the Trigger switch and then turn the RC off and on again

## 6.3 RC 1.0 System Specifications

- **Range** – 1 km or line sight
- **Battery capacity** – 1.5 hours
- **Frequency** – 868 MHz or 915 MHz, depending on region
- [Video deployment example](#)







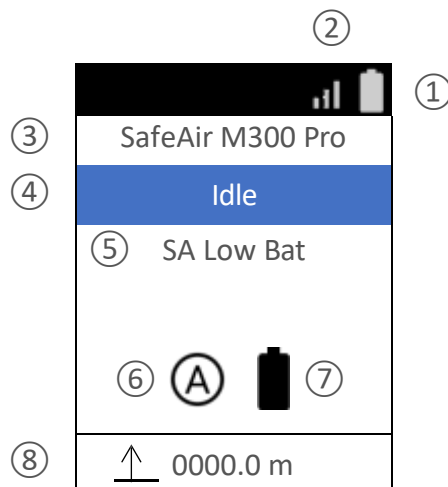





## 6.4 RC 2.0 System Ports & Switches



## 6.5 RC 2.0 Main Screen Messages



Category	Icon/Label	Buzzer indication	Meaning
① RC battery level			RC is charging
			Battery is at 80-100%
			Battery is at 60-80%
		Short beep every 20 seconds	Battery is at 20-60%
			Battery is critically low 0-20%
② RC Signal strength			Signal is at 75-100%
			Signal is at 50-75%
		3 long beeps every 5 seconds	Signal exists and below 50%
		3 short beeps every 5 seconds	No signal
③ Paired SafeAir system	SafeAir Mavic EU SafeAir Phantom EU SafeAir System Tail number		Indicates which system is paired to the RC. It's possible to assign the tail number for the SafeAir system via the desktop application.

Category	Icon/Label	Buzzer indication	Meaning
④ SafeAir State		Short beep at power up, 2 short beeps when entering idle	Systems is in Idle state, ready to operate
		Long beep when system enters arm state	System is armed and monitoring flight
		Chirp sound for 5 seconds	System was deployed due to freefall detection
		Chirp sound for 5 seconds	System was deployed due to critical angle breach
		Chirp sound for 5 seconds	System was deployed manually
⑤ SafeAir/ RC messages	SA Pyro Error		System detected an issue with the parachute.
	SA Orientation		System is not level
	SA Critical Bat		SafeAir battery is critically low
	SA Low Bat		SafeAir battery is low
	SA Flash Error		SafeAir flash storage error detected
	RC Low Bat		RC battery is low
⑥ SafeAir Triggering Mode			Auto detection and triggering
			Manual triggering only
⑦ SafeAir battery level			Battery is at 80-100%
			Battery is at 60-80%
			Battery is at 20-60%
			Battery is critically low
			System is connected to a power source
⑧ Current SafeAir Altitude	0000.0 m		The current altitude relative to the takeoff point. The display only updates when the system is armed. Refresh interval may vary.

## 6.6 RC 2.0 Idle Screen

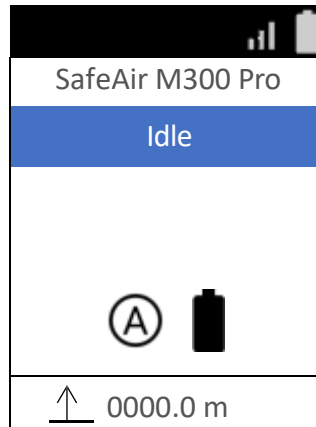

## 6.7 RC 2.0 Charging Indications

Turn the power switch is off and plug the RC to a 5V power source via the USB C cable.

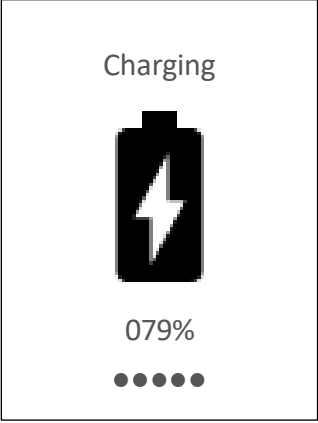
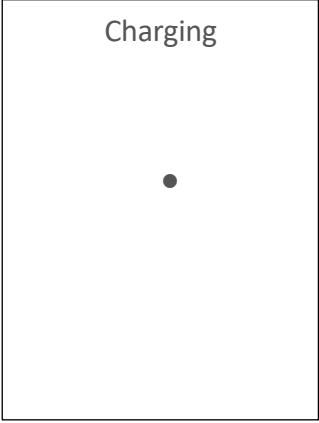











The main screen shows the charging status. Note: the percentage updates every few minutes	The following indication shows means low power. Charge the RC when this indication shows
	





## 6.8 RC 2.0 System Specifications

- **Range** – 1.3 km or line sight
- **Battery capacity** – 1.5 hours
- **Frequency** – 868 MHz or 915 MHz, depending on region
- [Video deployment example](#)



## System LED indications

Stage	LED	Buzzer	Indication	Required action
Init	Alternating Purple/Teal 	NA	System didn't sync with app for a long time	Connect system to ParaZero Desktop App to sync logs and check for updates
	Solid Orange 	NA	System battery is not fully charged	Charging the system is recommended but not mandatory
	Solid Red 	NA	System battery is low	Charging the system is mandatory for operational use
	Solid Green 	NA	System battery is fully charged	None
	Solid Yellow 	NA	System is initializing	None
	Flickering Red x1 	NA	Pyro error	<ol style="list-style-type: none"> <li>1. Make sure that the parachute cable is inserted</li> <li>2. Try using the pyro dummy</li> <li>3. Make sure that a pyro is installed</li> <li>4. Contact ParaZero support</li> </ol>
	(*) Flickering Yellow x1 	NA	RC channel is disconnected or in active state	<ol style="list-style-type: none"> <li>1. Check RC is on</li> <li>2. Check that RC button is not pressed</li> <li>3. Check RC is paired to device</li> </ol>
	Flickering Yellow x2 	NA	System is not level	Check system is positioned on a leveled surface
	Flickering Yellow x3 	NA	System storage error	Format storage with ParaZero Desktop App
Flickering Red x3 	Repeating 3 beep pattern	IMU error	<ol style="list-style-type: none"> <li>1. Restart system</li> <li>2. Contact ParaZero support</li> </ol>	
After init	Solid blue (Idle) 	Init finish: Single beep System disarm: two beeps	System is ready to be armed. Will not trigger the parachute.	None
	Solid Green (Armed) 	Single beep	System is armed, will deploy the parachute if necessary	None

	(*) Flickering Yellow x1 	NA	RC channel is disconnected or in active state	1. Check RC is on 2. Check that RC button is not pressed 3. Check RC is paired to device
	Flickering Yellow x2 (Only when system is in Idle) 	NA	System is not level	Check system is positioned on a level surface
	Solid Red (Triggered) 	Repeating beeping pattern with increasing frequency	System was triggered and parachute deployed	None
	Flickering Red x3 	Repeating 3 beep pattern	System battery is low	Finish mission and charge system. If system is armed, it will continue to operate, however if power decreases further, the system will cease to function due to inadequate battery level

(\*) ParaZero Remote Controller (RC) is an optional add-on and provides manual triggering capability. The LED indication is applicable for RC equipped systems.



# Operating Guidelines

## 8.1 Preflight

**Initial Conditions: The safety pin is in.**

Finalize all preflight procedures to your drone and payload. The following tasks are included in addition to the regular preflight tasks –

- Ensure that the thumb screws and the mounting legs screws are firmly closed.
- Connect the parachute cable to the SAP and store the pyro dummy. Ensure that the white line on the connector should face upwards.
- Verify that the electronic TerminateAir cables are connected (the short and the long black cables).
- Ensure that the fully extended propellers are able to freely spin without any existing or potential contact with the parachute system, and that the cables and strings do not obstruct any sensor.
- Carefully remove the safety pin, then turn on the RC (optional). At the end of the initialization process, the SmartAir LED should be **BLUE** and the RC 1.0 LED should be **GREEN** / RC 2.0 should display the Idle Screen.
- Turn on the power to the drone and verify that the electronic TerminateAir LEDs are on
- For RC-equipped systems – perform the FTS test as outlined on [item 8.5](#) below
- Go back to a recommended safe distance of a minimum of 5 meters

**Caution**



Flight in Sport Mode is not permitted while using the SafeAir system

## 8.2 Takeoff

- When ascending, you must climb to approximately 7 meters before the system will achieve an 'armed' status. Climb until you hear a single, long beep, and the LED turns **GREEN**, to ensure the system is armed.
- The system is now armed and fully ready for activation in case of an emergency.

## 8.3 Before Landing

When approaching landing, descend the drone slowly while keeping it level. Three seconds after the rotors are stopped on the ground, the parachute system automatically disarms. At this point, a long double-beep indicates the system is now disarmed, and the LED turns **BLUE**

**Caution**



Rough maneuvers in close proximity to the ground may result in inadvertent parachute deployment. Exercise caution during the landing process.



## 8.4 After Landing

- Place the safety pin inside the canister and (optional) turn off the RC.
- Disconnect the parachute cable from the SAP and connect the pyro dummy.

## 8.5 FTS Test (for RC equipped systems)

Applicable for RC 2.0 version 1.03 build 1.03 and later

In order to verify proper function of the FTS function perform the following steps. Make sure not to power the motors during the test. This checklist assumes that the preflight checks are complete.

- 1** Disconnect the parachute cable from the SAP and connect the pyro dummy. Press the middle button on the RC. The main menu will be displayed. Scroll down using the downward facing arrow button to "Integration" and press the middle button to select

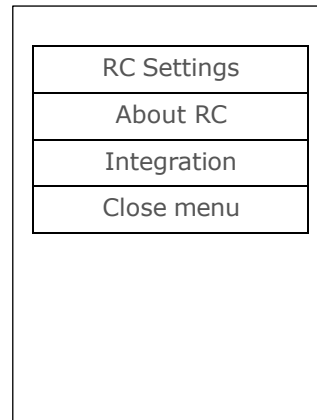

- 2** Select "Test Motor-cut" using the middle button

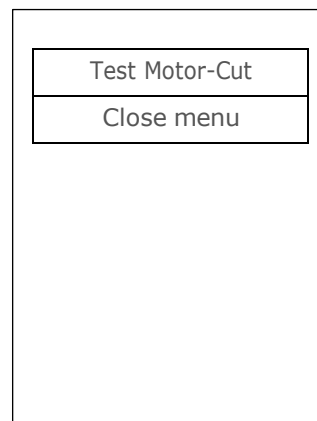

- 3** Scroll down using the downward facing arrow button to "OK" and long press the middle button to select

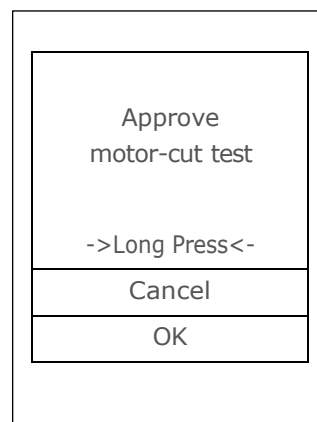

- 4 The following screen will be displayed on the RC, the drone will power down, and a single LED will extinguish on each side of the TerminateAir. Once the safety pin is put back into the SAP and RC is turned off, the drone will power up again.



- 5 Carefully remove the safety pin, then turn on the RC. At the end of the initialization process, the SmartAir LED should be **BLUE** and the RC 2.0 should display the Idle Screen

**Warning**



If the FTS test is not satisfactory, do not use the SafeAir system and contact ParaZero support at [support@parazero.com](mailto:support@parazero.com)



# Deployment

## 9.1 General

**For professional operators that comply with ASTM F3322-18 and are intended for flight over people, parachutes must be packed and repacked by ParaZero (or by an entity that has been certified and designated by ParaZero).**

The SafeAir M300 Pro / SafeAir M350 Pro includes an Autonomous Triggering System (ATS) that identifies most of the known critical failures and triggers the system autonomously. Should an emergency situation occur, the system deploys the parachute, stops the rotors and reduces impact energy upon landing.

In addition to the ATS, the [SafeAir system may also be triggered manually by the RC signal](#) (optional). In order to manually trigger the system, RC 1.0: press and hold the RC Trigger switch until the RC LED turns solid red accompanied by 3 short repeating beeps; RC 2.0: press and hold the RC Trigger switch until the parachute deploys.

The system can only deploy when it is in 'Armed' mode (**green** LED). Following a deployment, the LED turns **RED**. Insert the safety pin completely in to deactivate the system.

Contact us at [support@parazero.com](mailto:support@parazero.com) for the deployment analysis.

## 9.2 Repacking the parachute

Inspect the parachute and ensure there is no damage to the parachute, lines, or the main parachute strap. Inspect the canister, SmartAir, connectors, and the TerminateAir to make sure there is no apparent damage.

If there are tears, other suspected damage, or any uncertainty, please contact us at [support@parazero.com](mailto:support@parazero.com).

You will require all system components (except the TerminateAir), including a new pyro actuator for the repack process. Before you start, disconnect the FTS and parachute cables from the SmartAir and insert the safety pin completely in. Disconnect the bridles from both carabiners and secure the latter. Make sure you have found the yellow cap and the red base after the deployment and place all components on a clean dry surface large enough for the parachute.

The repack itself necessitates the parachute and a simple rubber band:

- 1** Place the parachute on the surface to ensure that the lines do not cross each other or are entangled, and that the lines are the same length, particularly the center line. This will require the upper part of the parachute to be folded as seen in the drawing below.
- 2** The parachute has 12 cells, fold all of them in half so that all the lines come out of the same place.
- 3** Divide the cells so there are 6 on one side of the lines and 6 in the other side.

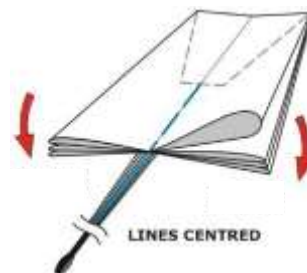

- 4 Fold 2/3 of the left cells towards the center of the parachute (so that the cells reach to the middle of the right folds).
- 5 Fold the 2/3 of the right cells under the folded parachute.



- 6 Fold the left and right part of the folded parachute over each other, in an accordion fashion. Fold one side to the middle and then fold the other side on top of it. It is important to keep the structure of the previous folds. Start the folding process from one end and use weights to keep the parachute depressed and folded, as you move along the length of the parachute.



- 7** Hold the lines adjacent to the parachute and fold them in a figure 8 shape using two fingers, all the way to the main strap (the main strap should fold once into the figure 8 shape) and lock them together with a thin rubber band.  
Do not fold the rubber band, it is supposed to be rather loose. For any doubts, contact [support@parazero.com](mailto:support@parazero.com)

Placing the parachute inside the canister necessitates the folded parachute, the yellow cap, the red base, and a new pyro actuator:

- 8** Remove the used pyro-actuator from the socket in the bottom of canister.
- 9** Place a new pyro-actuator in place according to the above-mentioned [procedure](#).
- 10** Place the red base into the bottom of the canister.
- 11** Place all the lines at the bottom of the canister on the red base, so that the folded part of the main strap (figure 8 shape) is put first on the red base and the rest of the lines are placed above it. The rest of the main strap should come out of the canister opening.
- 12** Insert the parachute to the canister in zigzag folds. Keep constant pressure on the folds for the parachute to fit.
- 13** Follow [Inserting the parachute](#) procedure, as of step 2.

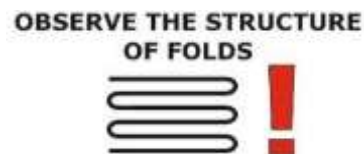
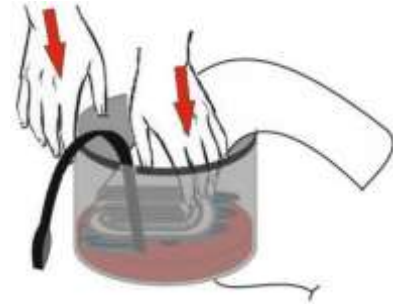

## Fly Safely!

Should you have questions, contact our support team at – [support@parazero.com](mailto:support@parazero.com)



*Operate Drones Everywhere, Safely*

**Telephone: +972-36885252**

**Email: [support@parazero.com](mailto:support@parazero.com)**

**Address: 30 Dov Hoz St.  
Kiryat Ono, Israel  
5555626**

